

ENCLOSURE MODEL: 600TLU880-AL

SAFE-T-COVER

JOB:

2710 LANDERS AVENUE, NASHVILLE, TN 37211

Drawn By: MW

Scale: NONE

Date:

615-259-4495, 800-245-6333, 615-259-4481 FAX

ELEVATION VIEW

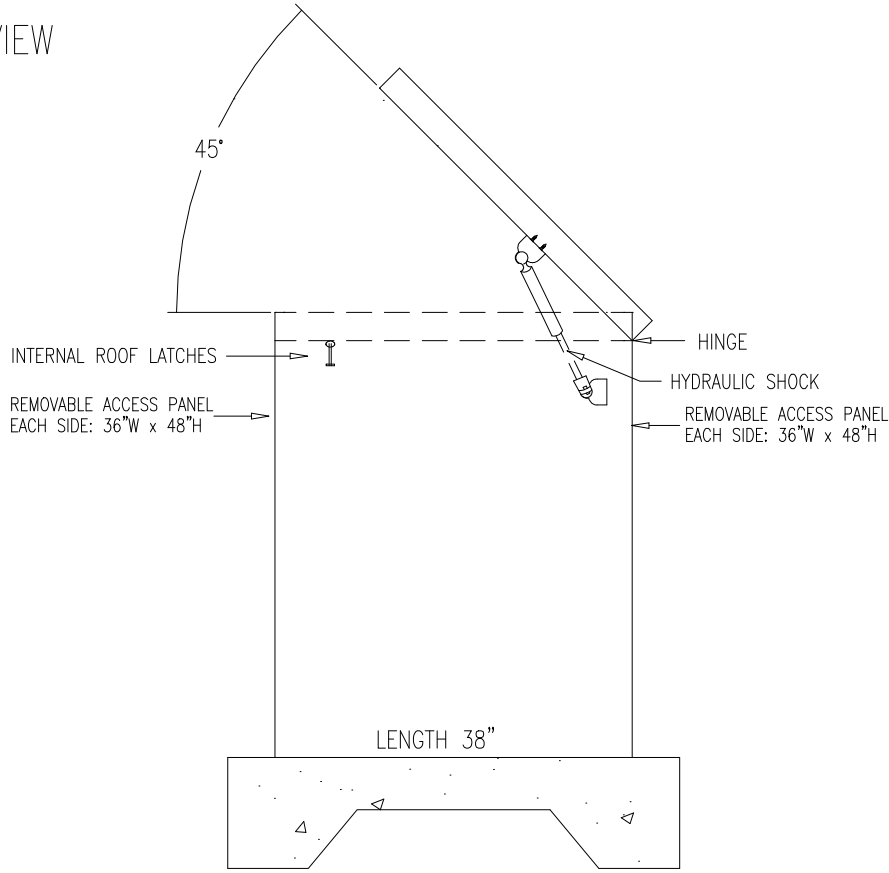

PLAN VIEW

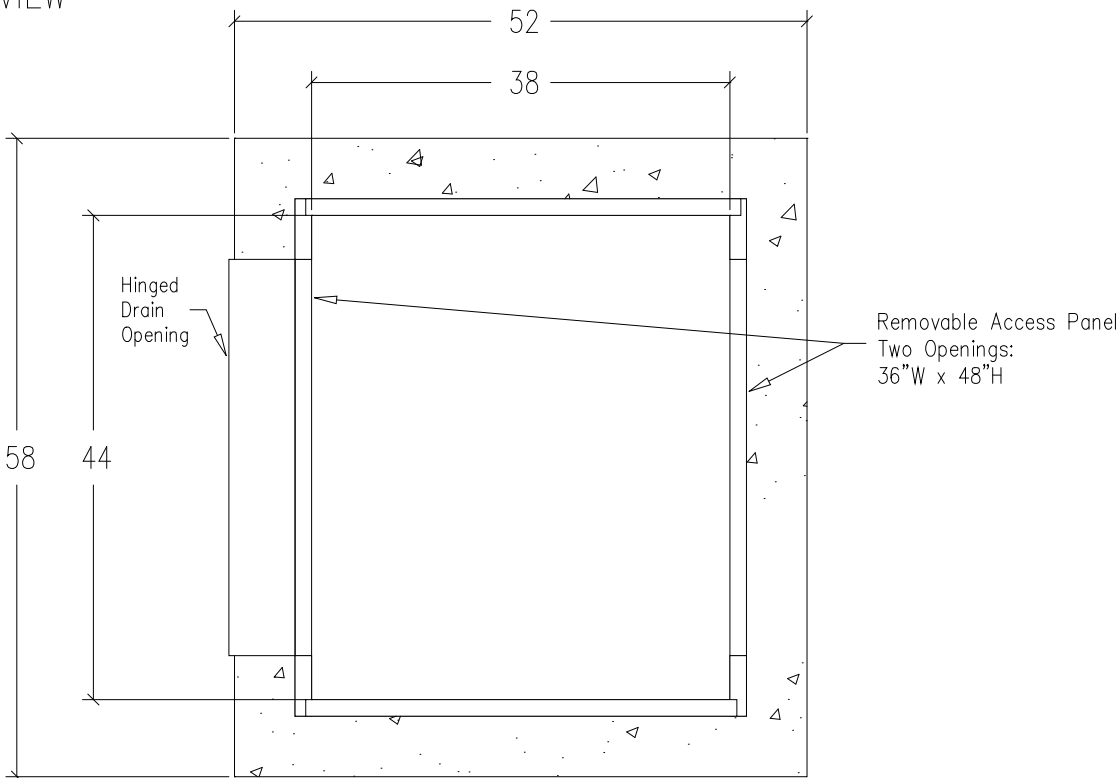

FN: 600TLU880

Sheet 1 of 1

6. HYDROCOWL MODEL 600TLU880-AL ENCLOSURE.

7. Enclosure inside dimensions: 44"W x 38"L x 48"H

8. Concrete pad is 52"W x 52"L

9. BFP -

1. Drawing NOT TO SCALE.

2. BFP dimensions furnished by

3. All dimensions are in inches.

4. Wall and insulation thickness is 1-1/2".

5. Roof and insulation thickness is 3".